

# Sharing Is Caring! Push Your Cloud Application to an OCI Registry

Silvin Lubecki & Djordje Lukic, Docker



KubeCon



CloudNativeCon

Europe 2020

*Virtual*



KubeCon



CloudNativeCon

Europe 2020



Silvin Lubecki  
Senior software engineer  
Docker  
[@silvin\\_docker](https://twitter.com/silvin_docker)



Djordje Lukic  
Senior software engineer  
Docker  
[@rumpl](https://twitter.com/rumpl)

*Virtual*



KubeCon



CloudNativeCon

Europe 2020

*Virtual*

## Outline:

- How registries work
- Case Study



KubeCon



CloudNativeCon

Europe 2020

*Virtual*

# Part 1 - How registries work

# What is container registry?



KubeCon



CloudNativeCon

Europe 2020

Virtual

JULIA EVANS  
@b0rk

## container registries

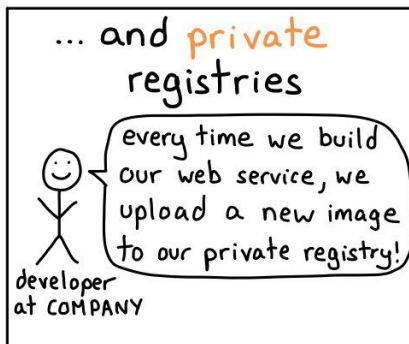
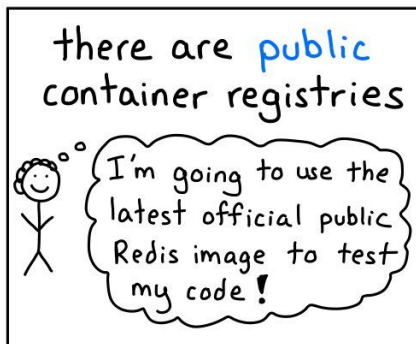
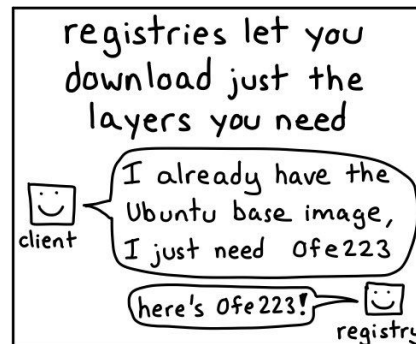
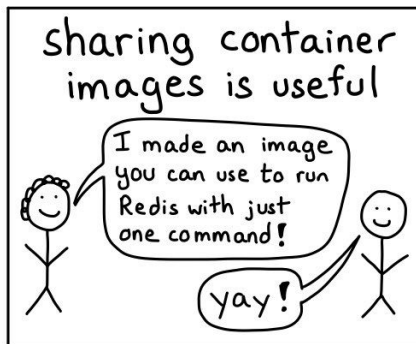

# OCI specifications 101



Established in 2015 under the Open Container Initiative (OCI) organisation

Split into three specifications ([github.com/opencontainers](https://github.com/opencontainers))

- [Distribution](#) (v1.0.0-rc0 / 2019-02-14)
- [Image](#) (v1.0.1 / 2017-11-08)
- [Runtime](#) (v1.0.1 / 2017-11-08)

Also under the OCI organisation

- [runc](#)
- [go-digest](#)



**OPEN** CONTAINER  
INITIATIVE

# What is an OCI image?



KubeCon



CloudNativeCon

Europe 2020

*Virtual*

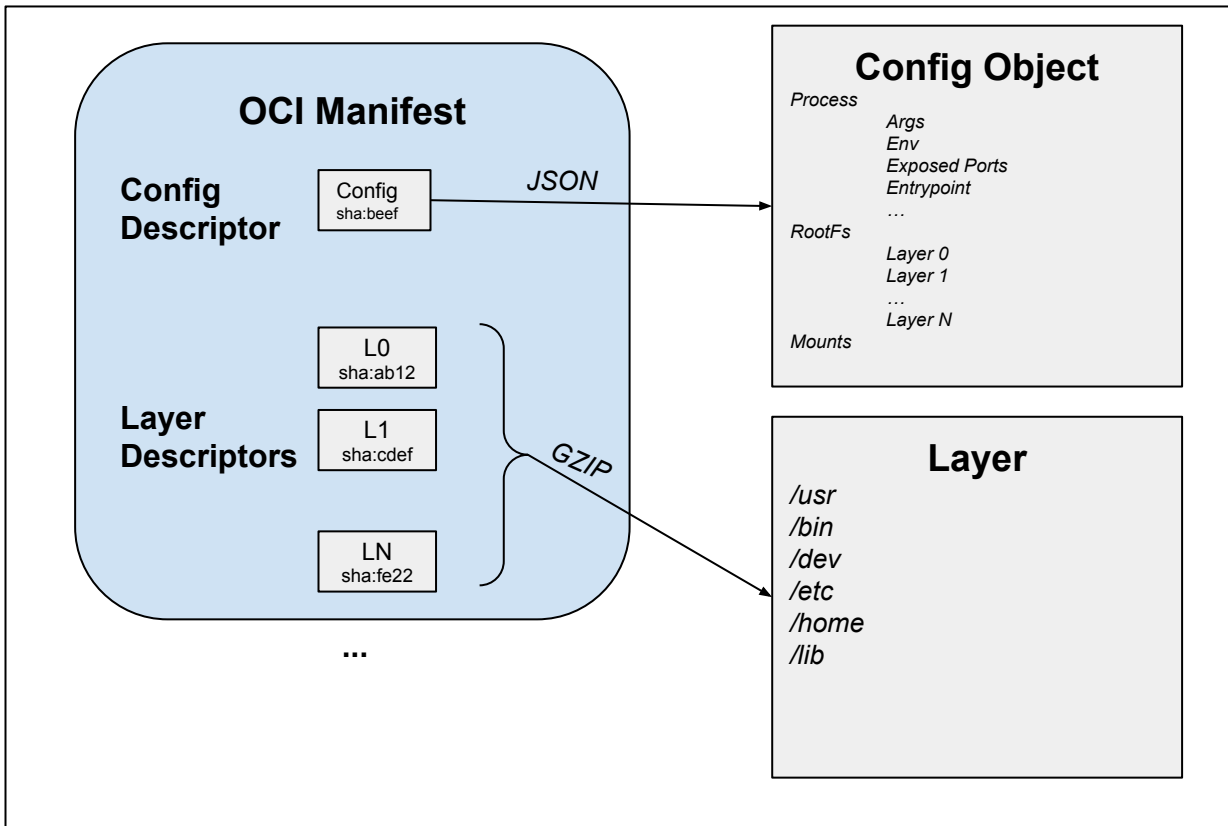

# What is an OCI image? Manifest



```
1 {
2   "schemaVersion": 2,
3   "config": {
4     "mediaType": "application/vnd.oci.image.config.v1+json",
5     "size": 7023,
6     "digest": "sha256:b5b2b2c507a0944348e0303114d8d93aaaa081732b86451d9bce1f432a537bc7"
7   },
8   "layers": [
9     {
10      "mediaType": "application/vnd.oci.image.layer.v1.tar+gzip",
11      "size": 32654,
12      "digest": "sha256:9834876dcfb05cb167a5c24953eba58c4ac89b1adf57f28f2f9d09af107ee8f0"
13    },
14    {
15      "mediaType": "application/vnd.oci.image.layer.v1.tar+gzip",
16      "size": 16724,
17      "digest": "sha256:3c3a4604a545cdc127456d94e421cd355bca5b528f4a9c1905b15da2eb4a4c6b"
18    },
19    {
20      "mediaType": "application/vnd.oci.image.layer.v1.tar+gzip",
21      "size": 73109,
22      "digest": "sha256:ec4b8955958665577945c89419d1af06b5f7636b4ac3da7f12184802ad867736"
23    }
24  ]
25 }
26
```



# What happens when I pull an image?



KubeCon



CloudNativeCon

Europe 2020

*Virtual*

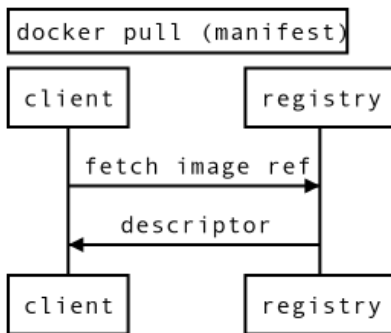

# What happens when I pull an image?

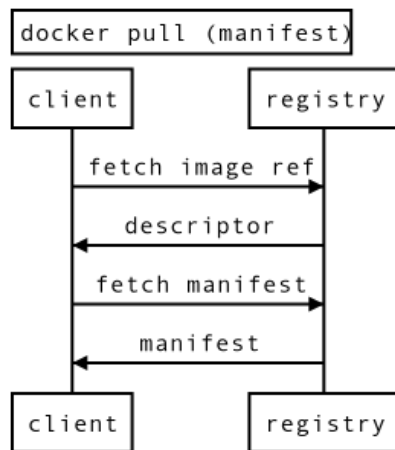

# What happens when I pull an image?

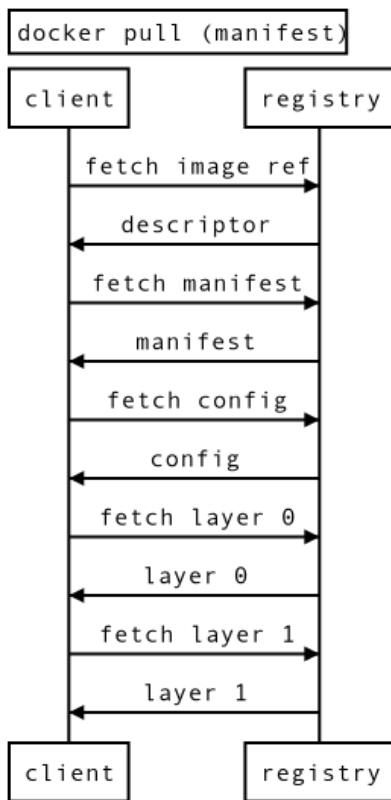

# What happens when I push an image?

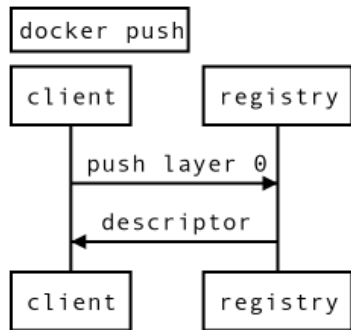

# What happens when I push an image?



KubeCon



CloudNativeCon

Europe 2020

*Virtual*

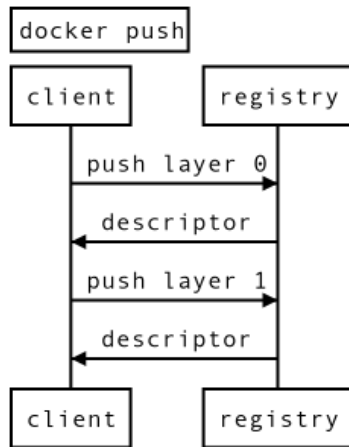

# What happens when I push an image?

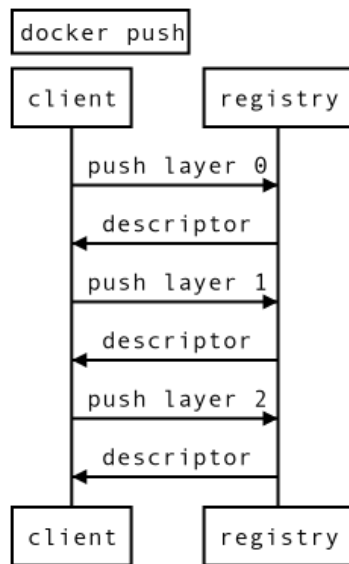

# What happens when I push an image?

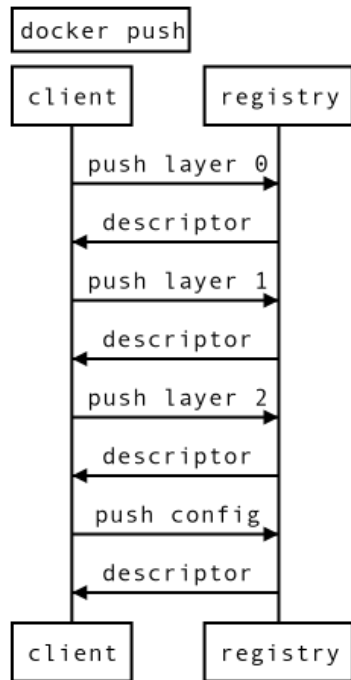

# What happens when I push an image?

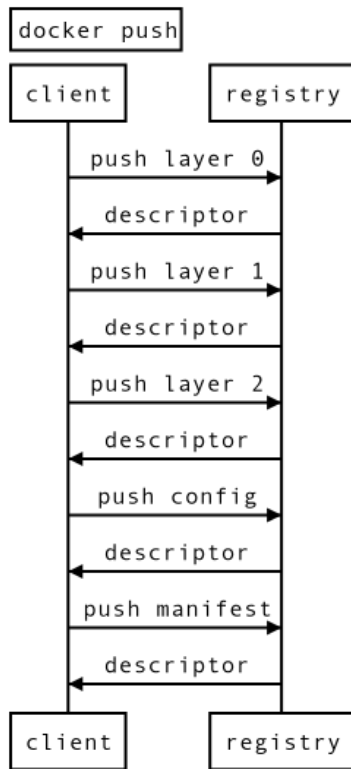



# What is a multi-arch OCI image?

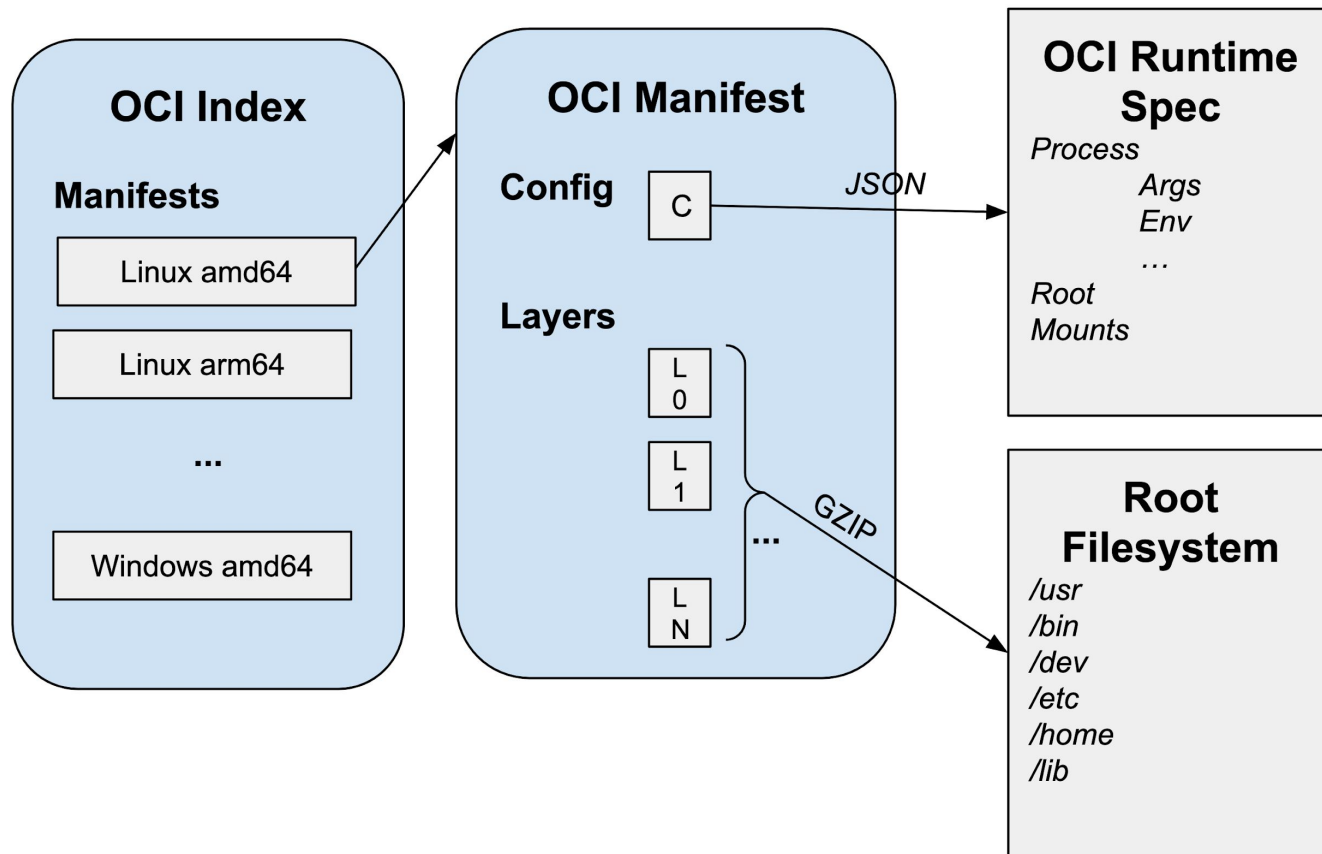

# What is an OCI image? Index



KubeCon



CloudNativeCon

Europe 2020

*Virtual*

```
1 {
2   "schemaVersion": 2,
3   "manifests": [
4     {
5       "mediaType": "application/vnd.oci.image.manifest.v1+json",
6       "size": 7143,
7       "digest": "sha256:e692418e4cbaf90ca69d05a66403747baa33ee08806650b51fab815ad7fc331f",
8       "platform": {
9         "architecture": "ppc64le",
10        "os": "linux"
11      }
12    },
13    {
14      "mediaType": "application/vnd.oci.image.manifest.v1+json",
15      "size": 7682,
16      "digest": "sha256:5b0bcabd1ed22e9fb1310cf6c2dec7cdef19f0ad69efa1f392e94a4333501270",
17      "platform": {
18        "architecture": "amd64",
19        "os": "linux"
20      }
21    }
22  ]
23 }
```

# What is a repository?

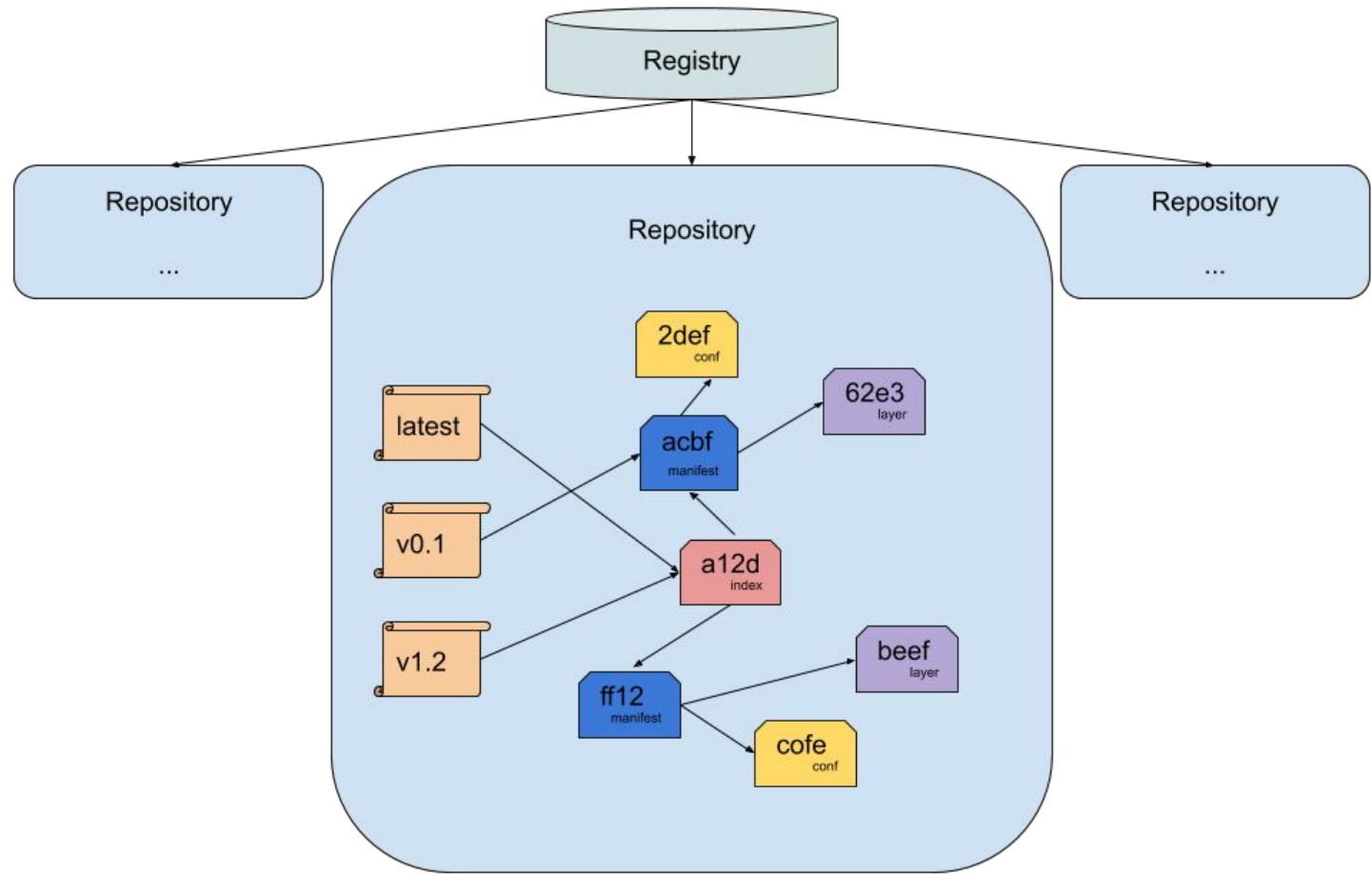

# Image reference vs tag vs digest

Syntax	Example
(1) repository	nginx => docker.io/library/nginx:latest
(2) namespace/repository	docker/dcl2020 => docker.io/docker/dcl2020:latest
(3) registry:port/namespace/repository	example.com:5000/user/repo => example.com:5000/user/repo:latest
(4) registry:port/namespace/repository:tag	example.com:5000/user/repo:v1.0.0
(5) registry:port/namespace/repository@algorithm:digest	example.com:5000/user/repo@sha256:38cfa07247...
(6) registry:port/namespace/repository:tag@algorithm:digest	example.com:5000/user/repo:v1.0.0@sha256:38cfa07247... => example.com:5000/user/repo@sha256:38cfa07247...



KubeCon



CloudNativeCon

Europe 2020

*Virtual*

# Part 2 - Case study

## Push a CNAB using OCI building blocks

# What is a CNAB?



KubeCon



CloudNativeCon

Europe 2020

*Virtual*

*“CNAB is a standard packaging format for multi-component distributed applications. It is not a platform-specific tool, and developers can bundle applications targeting environments spanning IaaS (like OpenStack or Azure), container orchestrators (like Kubernetes or Nomad), container runtimes (like local Docker or ACI), and cloud platform services (like object storage or Database as a Service).”*

```
$ porter build <bundle>
$ porter publish <bundle>
$ docker app install <bundle>
$ duffle uninstall <bundle>
```

[github.com/cnabio/cnab-spec](https://github.com/cnabio/cnab-spec) for more information

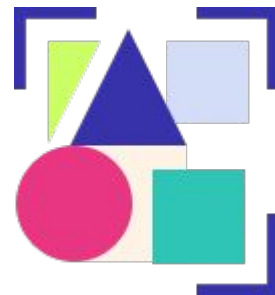

# What is a bundle.json?



KubeCon



CloudNativeCon

Europe 2020

*Virtual*

```
1 {
2   "name": "helloworld",
3   "description": "An example hello world Cloud-Native Application Bundle",
4   "invocationImages": [
5     {
6       "contentDigest": "sha256:c00ffee...",
7       "image": "example/helloworld:0.1.0",
8       "imageType": "docker"
9     }
10  ],
11  "images": {
12    "my-microservice": {
13      "contentDigest": "sha256:deadbeef...",
14      "description": "my microservice",
15      "image": "example/microservice:1.2.3"
16    }
17  },
18  "credentials": {
19    "hostkey": {
20      "env": "HOST_KEY",
21      "path": "/etc/hostkey.txt"
22    }
23  },
24  "parameters": {
25    "backend_port": {
26      "definition": "http_port",
27      "description": "The port that the back-end will listen on",
28      "destination": {
29        "env": "BACKEND_PORT"
30      }
31    }
32  },
33  "definitions": {
34    "http_port": {}
35  }
36 }
```

# Push a bundle as an OCI index

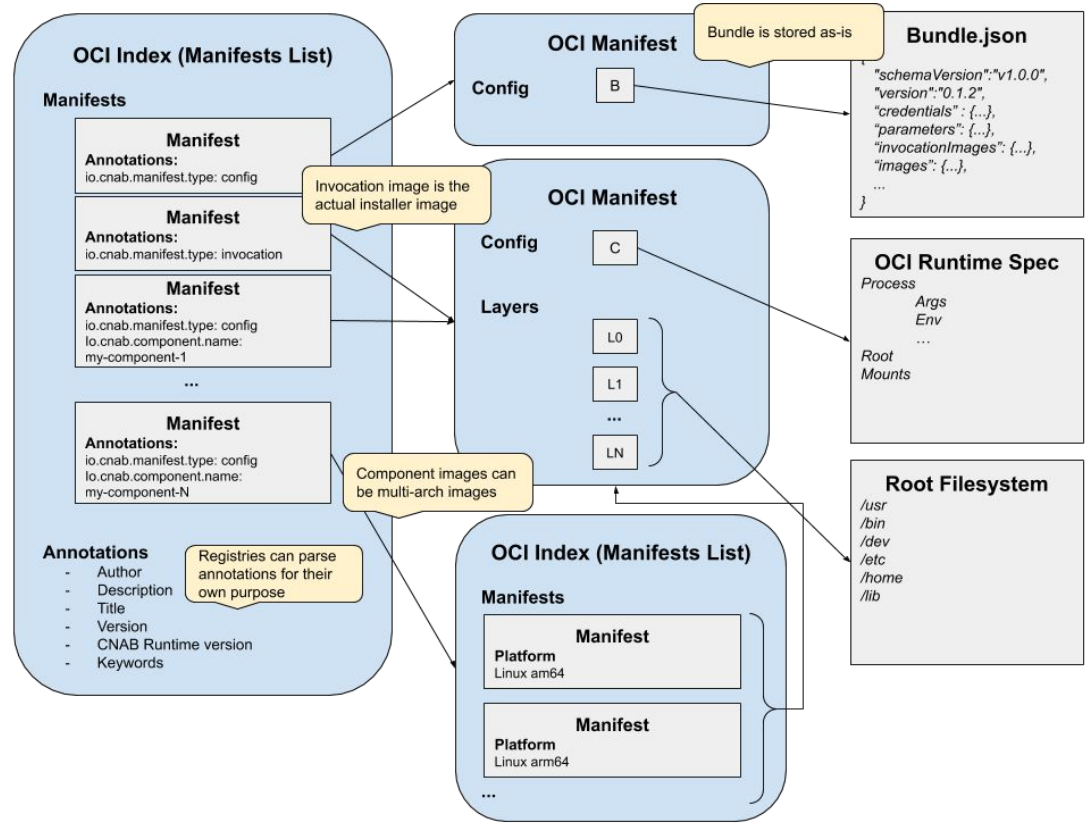





KubeCon



CloudNativeCon

Europe 2020

*Virtual*

**Demo !**

# Battle scars with the registry landscape



Registry	CNAB compatible
ACR	Yes
Artifactory	No
Docker Hub	Yes
Digital Ocean	Yes
ECR	No
GCR	Yes
Github Packages	No
Nexus	No
Quay	No

## Main issues discovered:

- OCI Index not supported, only Docker Manifest lists format (Docker Hub before 2019)
- Could not push without tagging (ECR)
- Can't mix Manifest lists with OCI Indexes (bundle using service images from multiple vendors)
- Empty or no layer (for storing config object) (GCR)
- No multi-arch support (Nexus)
- Custom Mediatype forbidden

# Future of OCI Specifications



KubeCon



CloudNativeCon

Europe 2020

*Virtual*

- OCI conformance tests <https://conformance.opencontainers.org/>
- [Artifacts](#)

# Tools and libraries to play with images



KubeCon



CloudNativeCon

Europe 2020

*Virtual*

- [github.com/docker/distribution](https://github.com/docker/distribution)
- [github.com/containerd/containerd](https://github.com/containerd/containerd)
- [github.com/google/go-containerregistry](https://github.com/google/go-containerregistry)
- [github.com/wagoodman/dive](https://github.com/wagoodman/dive) to check what's inside an image
- [github.com/cnabio/cnab-to-oci](https://github.com/cnabio/cnab-to-oci)



KubeCon



CloudNativeCon

Europe 2020



HELM

*Virtual*



KEEP CLOUD NATIVE

CONNECTED

