



Introduction to Istio Configuration: Today & Tomorrow

May 2, 2018 [schedule](#)

Joy Zhang [@JoyXZhang](#), Google

What is Istio? istio.io

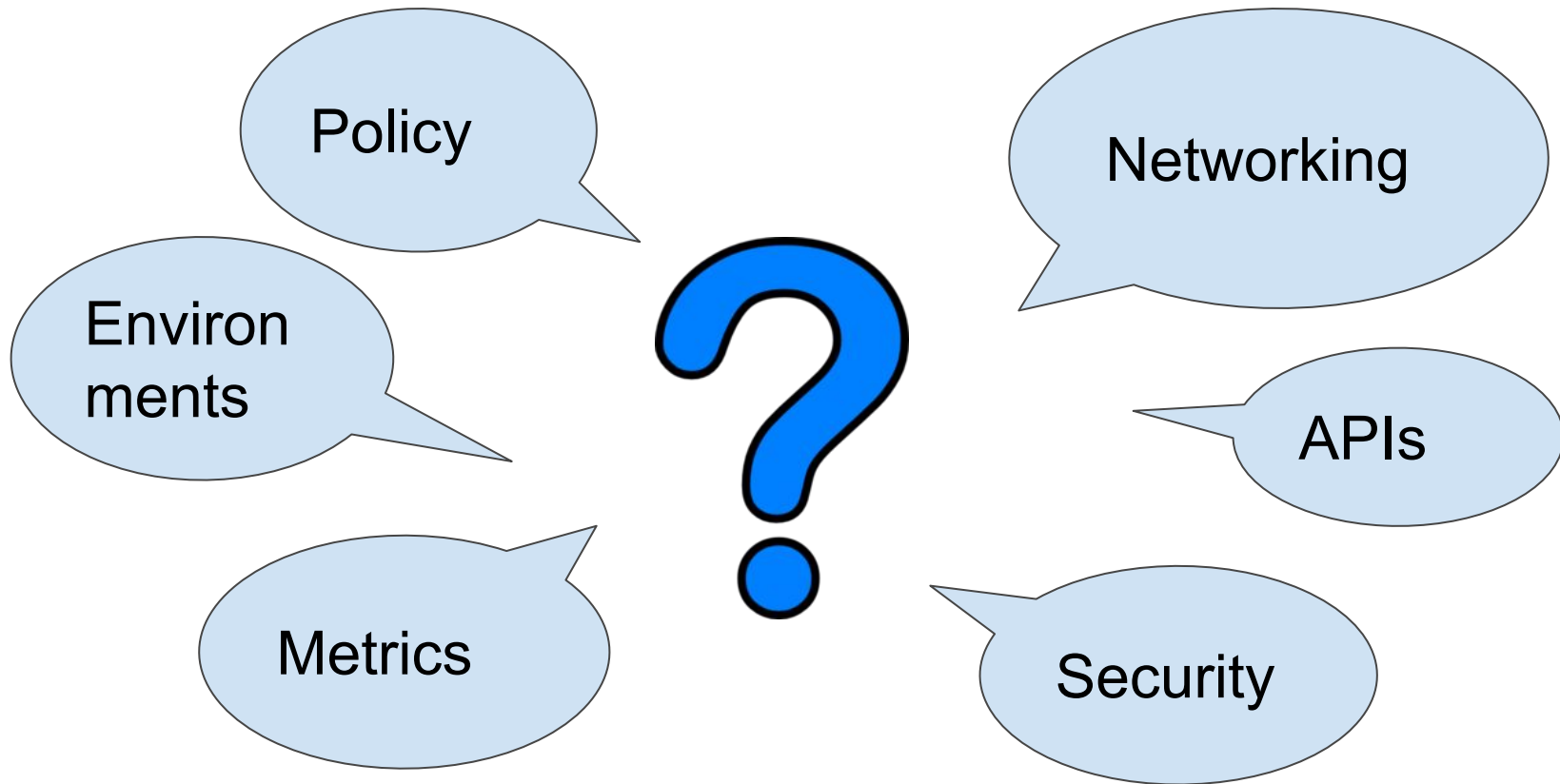

What is Istio? istio.io

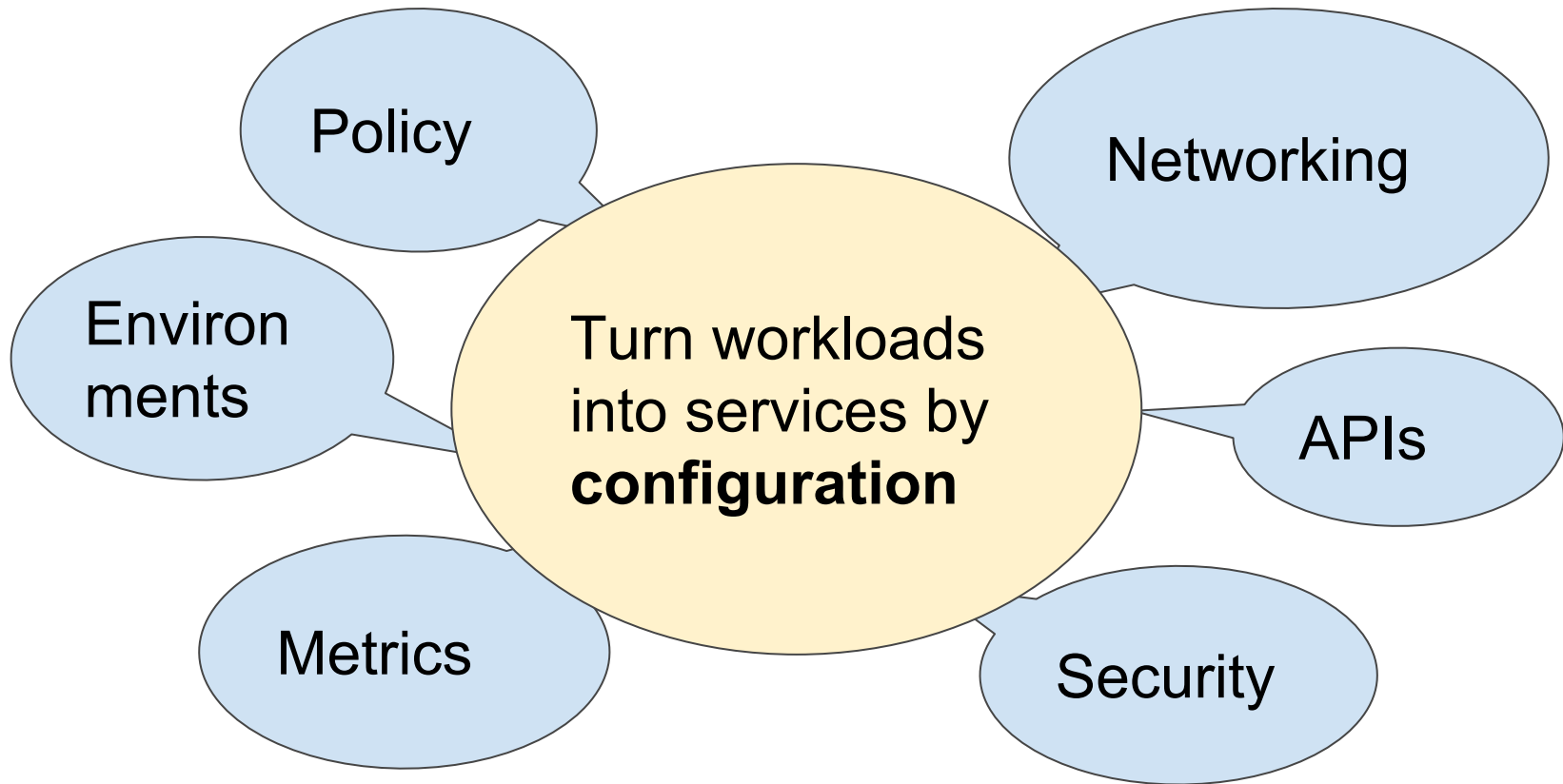

What does that mean?

- Istio allows you to
 - Switch traffic between prod and canary.
 - Switch mTLS and non-mTLS.
 - Expose an external service endpoints.
 - Specify an API vocabulary for a service.
 - Add rate limiting.
 - Add monitoring metrics.
 - ... many, many.
- through configurations, all ***without*** dev work.

Istio architecture

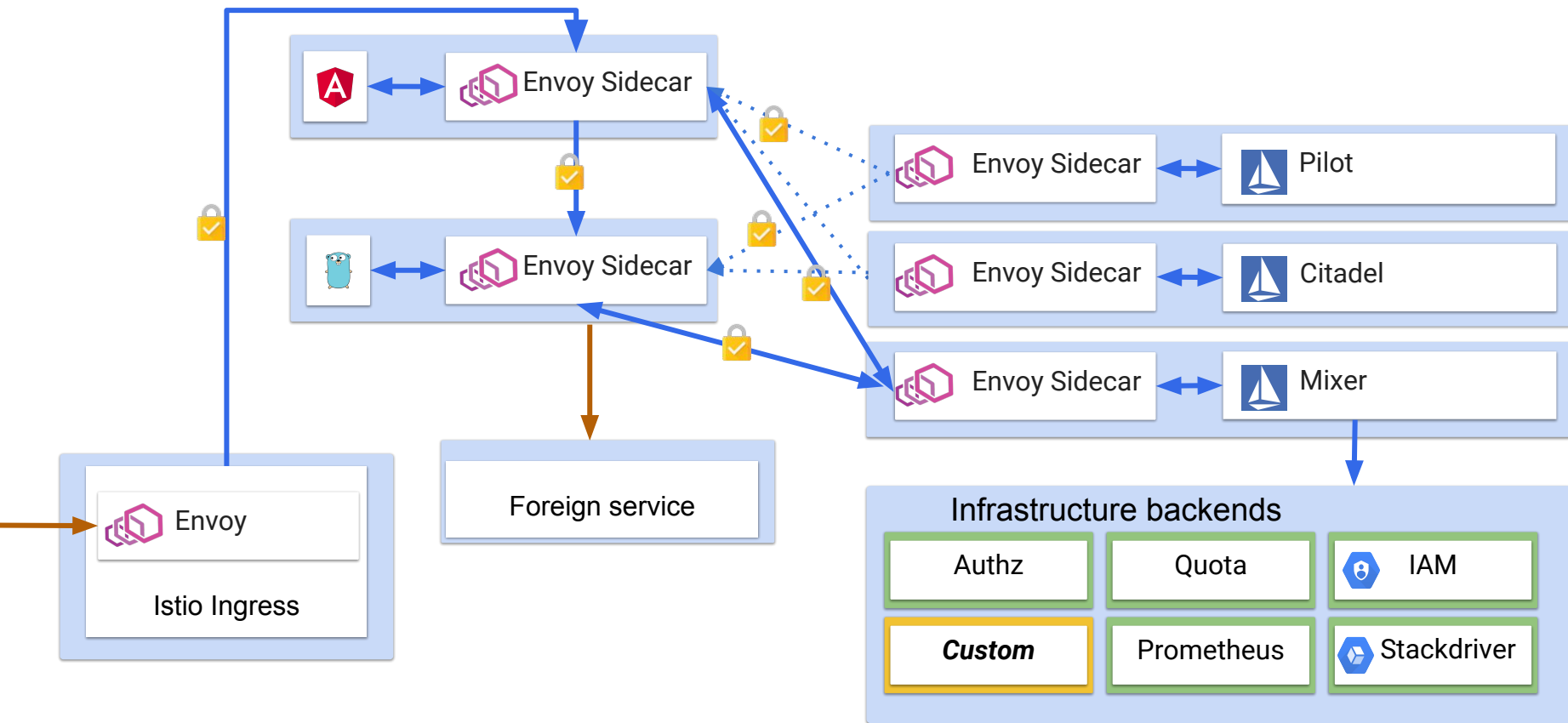

Configuration flow [link](#)

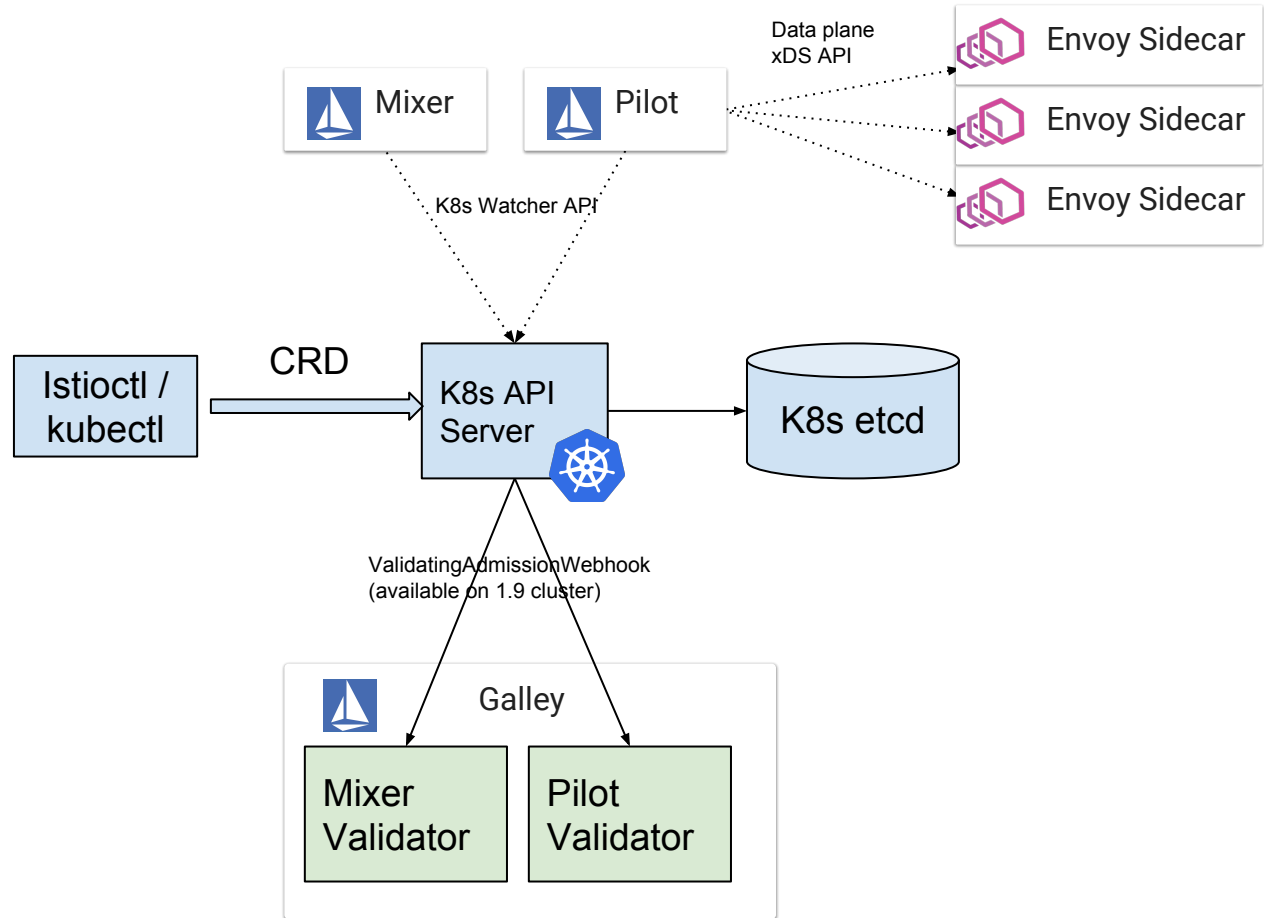

Istio CRDs <https://istio.io/docs/reference/config/>

```
@kubectl get crd
```

NAME	KIND
attributemanifests.config.istio.io	CustomResourceDefinition.v1beta1.apiextensions.k8s.io
checknothings.config.istio.io	CustomResourceDefinition.v1beta1.apiextensions.k8s.io
deniers.config.istio.io	CustomResourceDefinition.v1beta1.apiextensions.k8s.io
destinationpolicies.config.istio.io	CustomResourceDefinition.v1beta1.apiextensions.k8s.io
egressrules.config.istio.io	CustomResourceDefinition.v1beta1.apiextensions.k8s.io
fakeconfigs.config.istio.io	CustomResourceDefinition.v1beta1.apiextensions.k8s.io
globalbgpconfigs.crd.projectcalico.org	CustomResourceDefinition.v1beta1.apiextensions.k8s.io
globalfelixconfigs.crd.projectcalico.org	CustomResourceDefinition.v1beta1.apiextensions.k8s.io
globalnetworkpolicies.crd.projectcalico.org	CustomResourceDefinition.v1beta1.apiextensions.k8s.io
ingressrules.config.istio.io	CustomResourceDefinition.v1beta1.apiextensions.k8s.io
ippools.crd.projectcalico.org	CustomResourceDefinition.v1beta1.apiextensions.k8s.io
listcheckers.config.istio.io	CustomResourceDefinition.v1beta1.apiextensions.k8s.io
listentries.config.istio.io	CustomResourceDefinition.v1beta1.apiextensions.k8s.io
logentries.config.istio.io	CustomResourceDefinition.v1beta1.apiextensions.k8s.io
memquotas.config.istio.io	CustomResourceDefinition.v1beta1.apiextensions.k8s.io
metrics.config.istio.io	CustomResourceDefinition.v1beta1.apiextensions.k8s.io
mockconfigs.config.istio.io	CustomResourceDefinition.v1beta1.apiextensions.k8s.io
noops.config.istio.io	CustomResourceDefinition.v1beta1.apiextensions.k8s.io
prometheuses.config.istio.io	CustomResourceDefinition.v1beta1.apiextensions.k8s.io
quotas.config.istio.io	CustomResourceDefinition.v1beta1.apiextensions.k8s.io
reportnothings.config.istio.io	CustomResourceDefinition.v1beta1.apiextensions.k8s.io
routerules.config.istio.io	CustomResourceDefinition.v1beta1.apiextensions.k8s.io
rules.config.istio.io	CustomResourceDefinition.v1beta1.apiextensions.k8s.io

Scale linearly with components/features

User problems with the existing model

- Config authoring [link](#)
 - Lack of abstraction, too much implementation details.
 - Usability may suffer as a result of performance optimization.
 - Poor diagnosability.
 - Minimal mesh wide reuse.
 - Unsatisfactory resource ACL model.
- Config distribution [link](#)
 - Lack of control of the rollout.
 - Lack of isolation and serialization.
 - Difficult to rollback.
 - Eventual consistency & emergent config state.
 - Lack of automation for multi-environments.



What's next?

Introduce a configuration pipeline

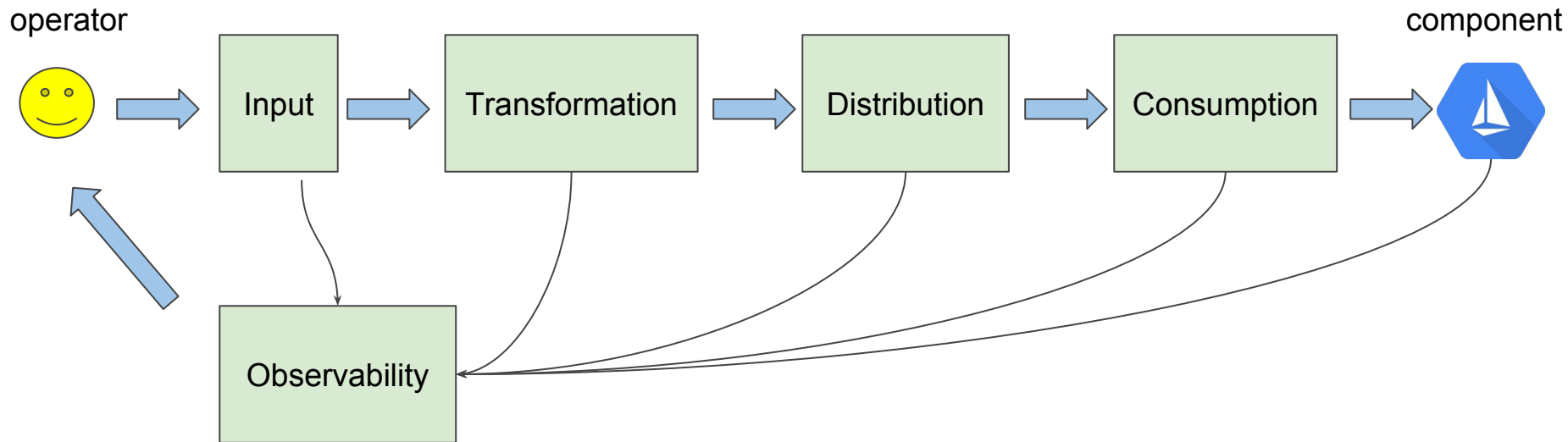

New API layers

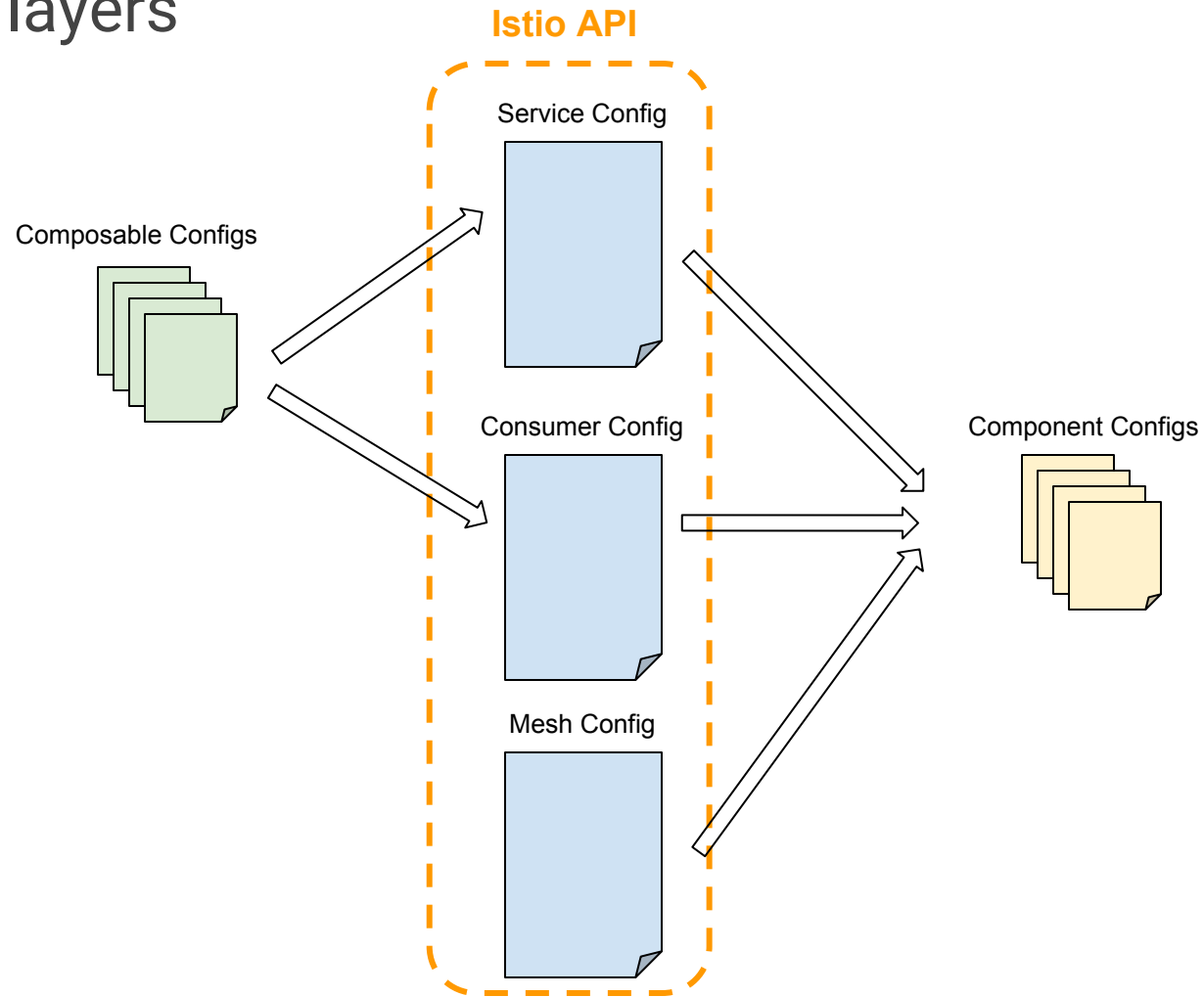

Component centric to feature centric <https://goo.gl/41fAYK>

Small amount of global runtime configs

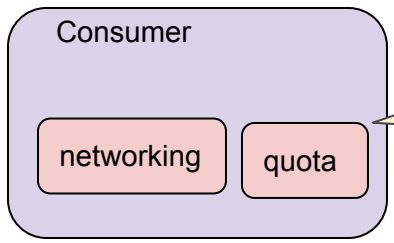
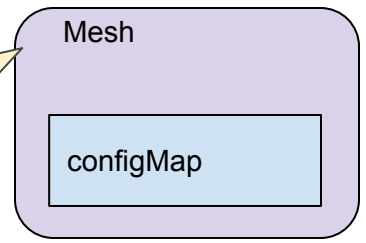

Configs for consuming Istio services, a consumer overriding model for service config.

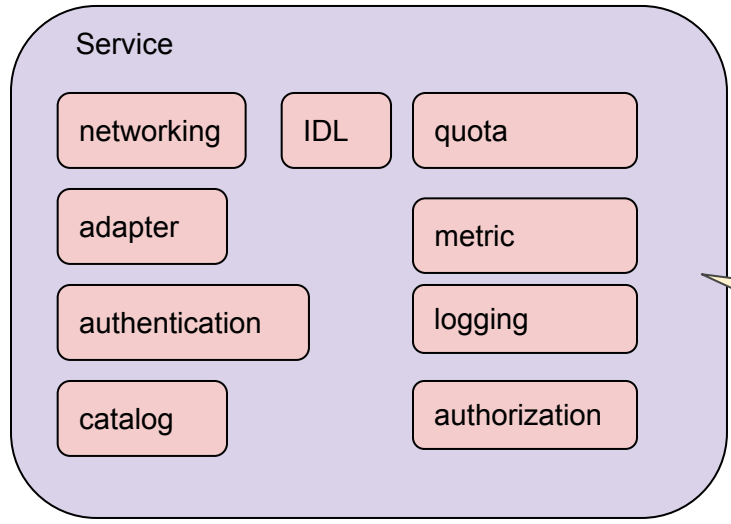

Configs for the producer service. Most of the configs Istio operators expect to write.

Composable authoring model

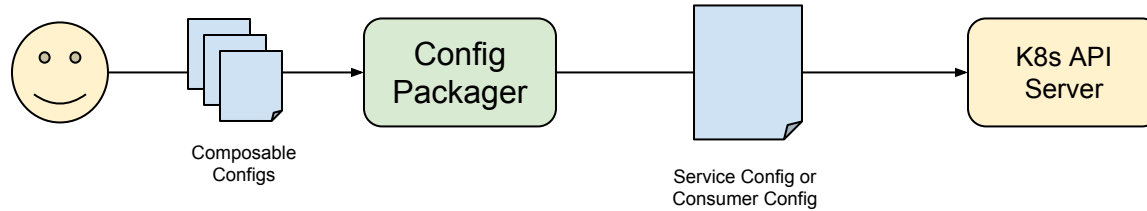

- Reusable and scalable.
- Composable config is non-architectural, allow customized solutions.
- External tooling tailors for small/large mesh use cases.
 - ACL resource hierarchies.
 - Integration with CI/CD.

Config processing engine -- Galley

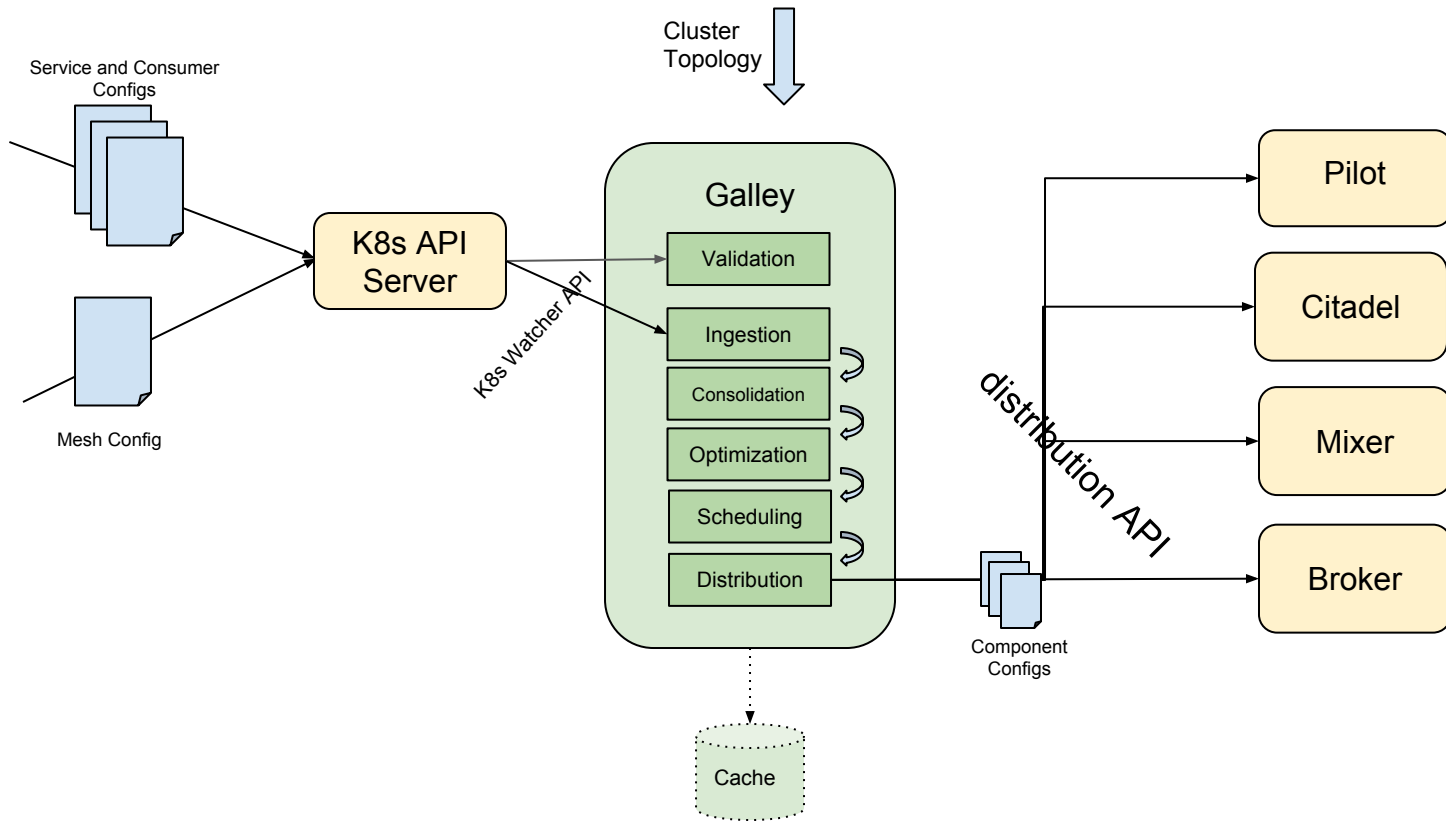

More about Galley

- In-cluster.
- Low latency delivery.
- Sharding/downscoping, less config for components.
- Rollout status.
- Compatible to K8s controller pattern.

Multi-cluster/environments solution

Manual

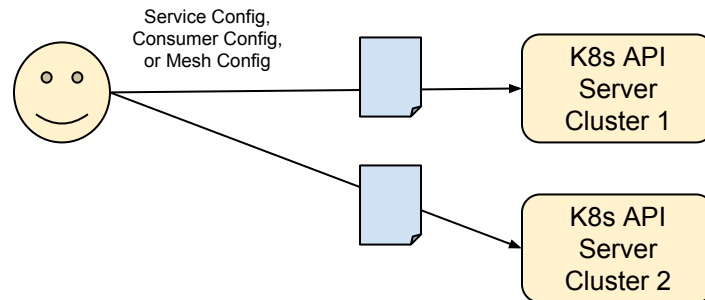

Automatic

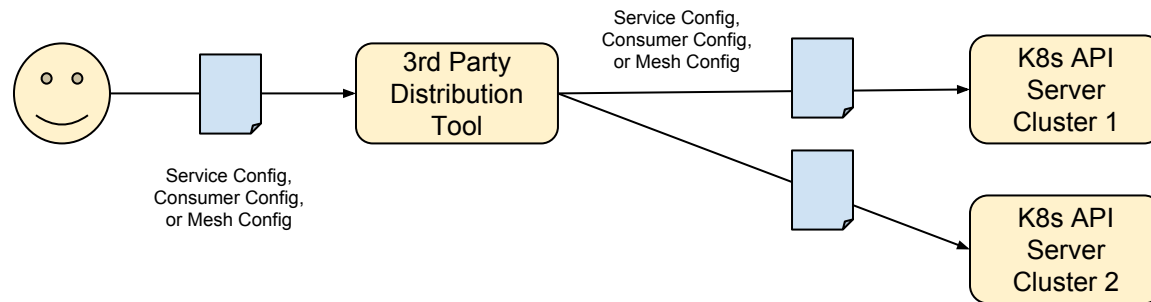

Where are we now?

Galley Click-stop 0 [link](#)

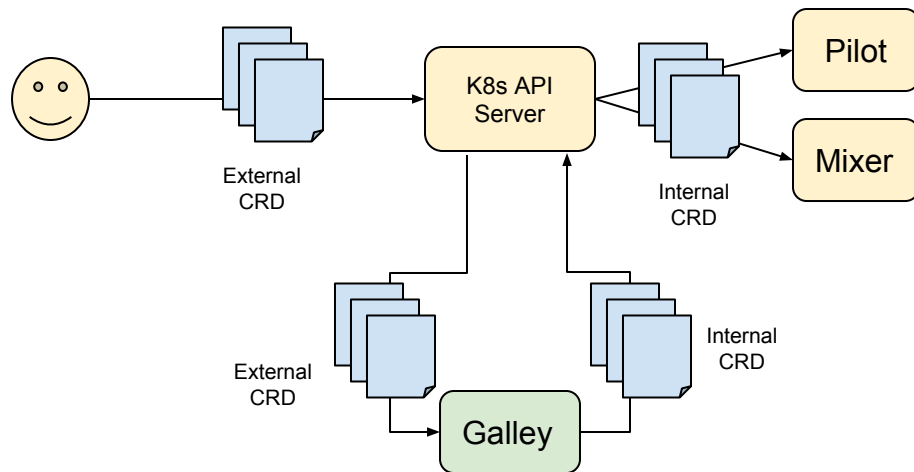

Further readings

- General about Istio:
 - Site: <https://istio.io>
 - GitHub: <https://github.com/istio/>
- Istio config:
 - API: <https://istio.io/docs/reference/config/>
 - Working group contacts: [link](#)
 - Architecture design: <https://goo.gl/Jft4jf>
 - Roadmap: [link](#)



Thank you!

Config resource model [link](#)

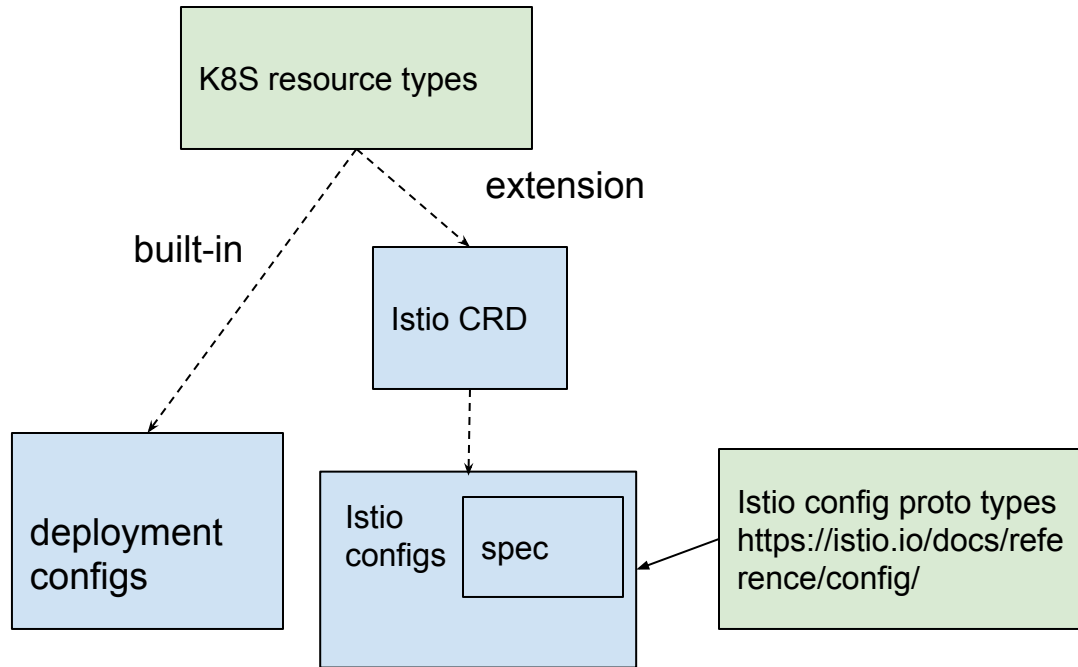

CRD is a K8S API extension
[read more](#)

Requirements

- Format
 - Focus on a service operator oriented experience.
 - Intent-driven, declarative.
 - Reusability on large meshes.
 - Safe API upgrade.
 - Consistent ACL model.
- Distribution
 - Rollout staging.
 - Config resource lifecycle management.
 - Simple and efficient runtime configuration.
 - Monitoring.